

# User Manual

---

Electronic handle with  
access control

**SecureEntry-HL200**

## Table of contents

Specifications: .....	3
Set contents:.....	5
Features: .....	5
Door opening direction .....	6
Swipe left and right.....	6
Adjusting the direction of the groove.....	8
Accessories for doors of different thicknesses.....	8
Pre-Installation Considerations.....	9
Installation.....	10
Points to check after installation .....	13
Smart Lock User Manual (Five in One).....	13
1. Function & Operation.....	13
2. Initial state .....	13
3. Managing the Lock Function .....	14
4. Setting the Administrator .....	14
5. Typical User Setting.....	15
6. System Settings .....	15
App configuration (TUYA Smart) – optional.....	16
Other considerations.....	17
Smart Lock User Manual .....	18
1. Registration and login to the TUYA application.....	18
2. Creating Houses and Rooms .....	19
3. Adding a WiFi Lock .....	20
4. Home page .....	21
5. Dynamic Password.....	22
6. Message Center .....	23
7. User management .....	23
8. Log Log.....	24
9. Temporary Password.....	25
10. Interception Alarm.....	26
11. Factory reset.....	27

## Specifications:

- **Warranty:** 1 year
- **Material:** Aluminum alloy
- **Type of device:** electronic door handle with lock and access control
- **Verification Types:** Password, Fingerprint, RFID Card, TUYA APP, Key
- **Lock body:** two tongues or single latch
- **Fingerprint Recognition:** Semiconductor FPC
- **Number of administrators in the database:** 9
- **Capacity of users in the database:** 300 (fingerprint, password, card)
- **Voice prompts:** Easy to set up with smart voice prompts
- **Keyboard:** Standard 12-bit touch keyboard
- **Additional functions:** tamper alarm, touch keypad, cooperation with TUYA app
- **Fingerprint Identification Angle:** 360°
- **False bounce rate:**  $\leq 0.1\%$
- **False diagnosis rate:**  $\leq 0.0001\%$
- **Password length:** 4-8 digits
- **Operating voltage:** 6V (4 x 1.5V AA alkaline batteries or external USB uninterruptible power supply can be used)
- **Starting current:**  $\leq 50\mu\text{A}$
- **Dynamic current:**  $\leq 180\text{mA}$
- **Response time:**  $\leq 0.1$  seconds
- **Unlock Time:**  $\leq 1$  second
- **Backup power supply:** 5VDC
- **Suitable Door Type:** Stainless Steel Door / Security Door / Copper Door / Wooden Door
- **Suitable door thickness:** 35-50mm
- **Application:** Home, Apartment, Modern Office, Campus, Dormitory

- **Lock size:** 250\*60\*28mm
- **Operating temperature:** -24°C ~60°C
- **Operating humidity:** 20~90%

## Set contents:

- Front zipper
- Lock back plate
- Connecting post 30/35 mm
- Double mortise locks
- Battery cover
- 80 mm shank
- M4X30 45mm Screw
- Strike box (wooden door only)
- Hitch plate
- 4.2x25 mm screw (wooden door only)
- Battery
- Mechanical wrench
- MI Card

## Features:

- The electronic handle allows you to manage access to rooms and buildings by means of a password, fingerprint and card
- Made of high-quality aluminum alloy, it is resistant to damage
- Elegant design
- Ability to control the lock from a smartphone using the TUYA app

## Door opening direction

### 1. Opening with the right handle

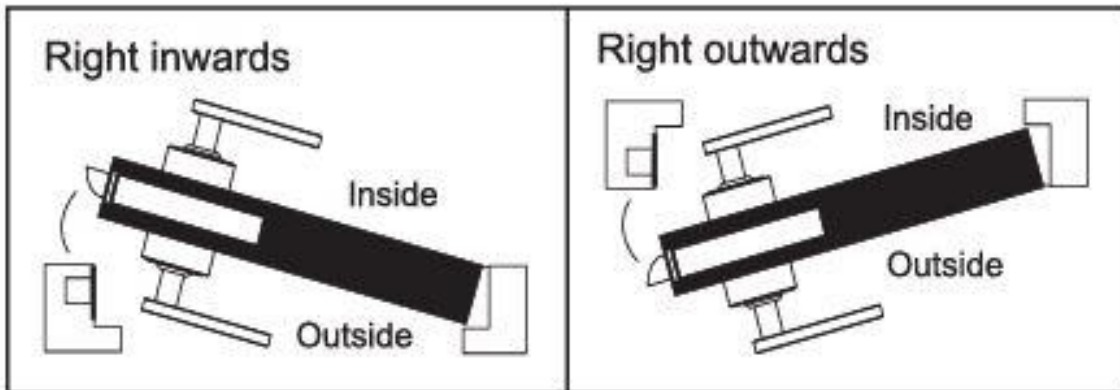

### 2. Opening with the left handle

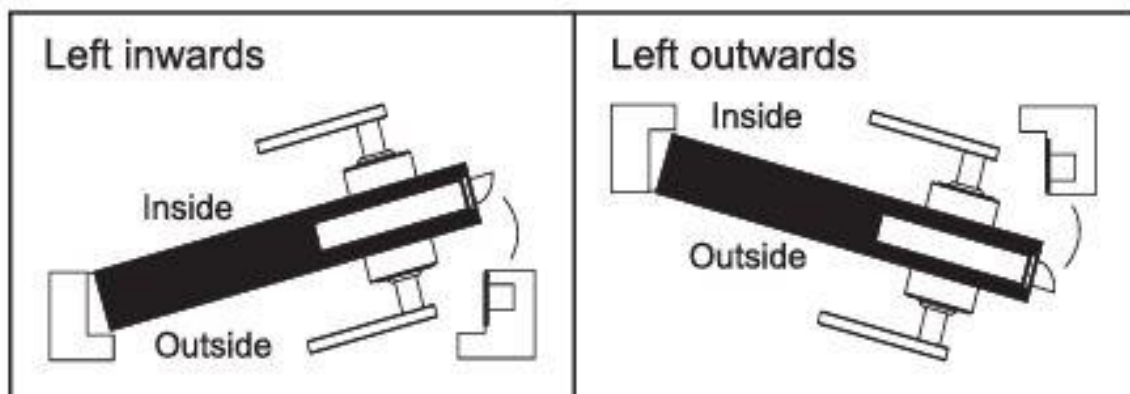

## Swipe left and right

Depending on your needs, you need to adjust the left and right sides with a screwdriver. To do this, loosen the screw, then rotate the handle 180 degrees and attach the screw.

**Note:** Do not remove the screw in the handle hole, if it is broken, it may void the warranty.

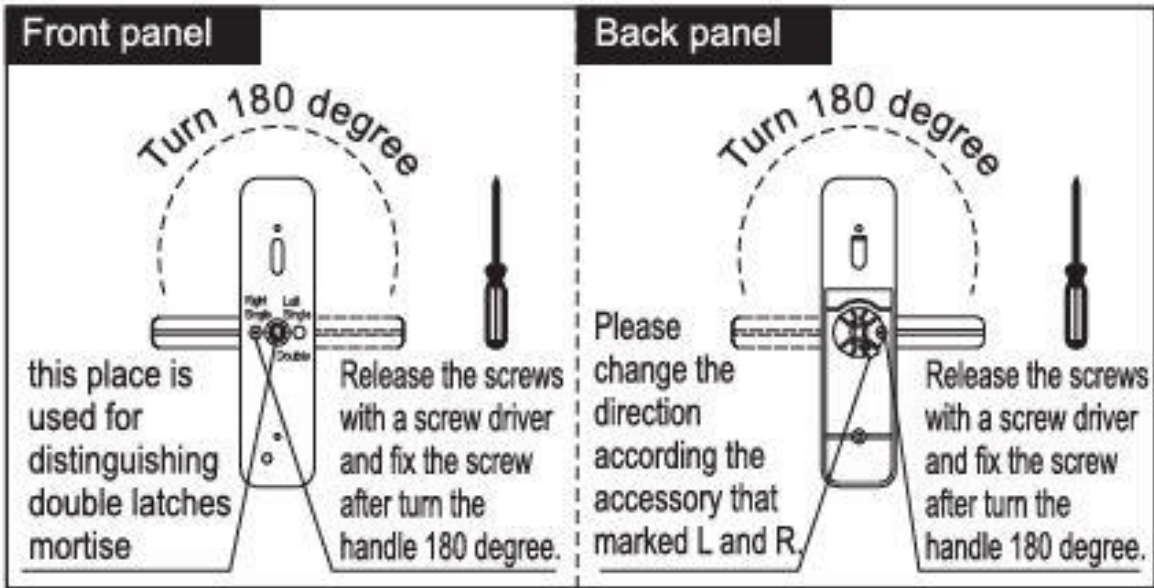

1. This place is used to differentiate between double mortise locks
2. Loosen the screws with a screwdriver and fix the screw after turning the handle 180 degrees.
3. Change the direction according to the accessories marked with the letters L and R.
4. Loosen the screws with a screwdriver and fix the screw after turning the handle 180 degrees.

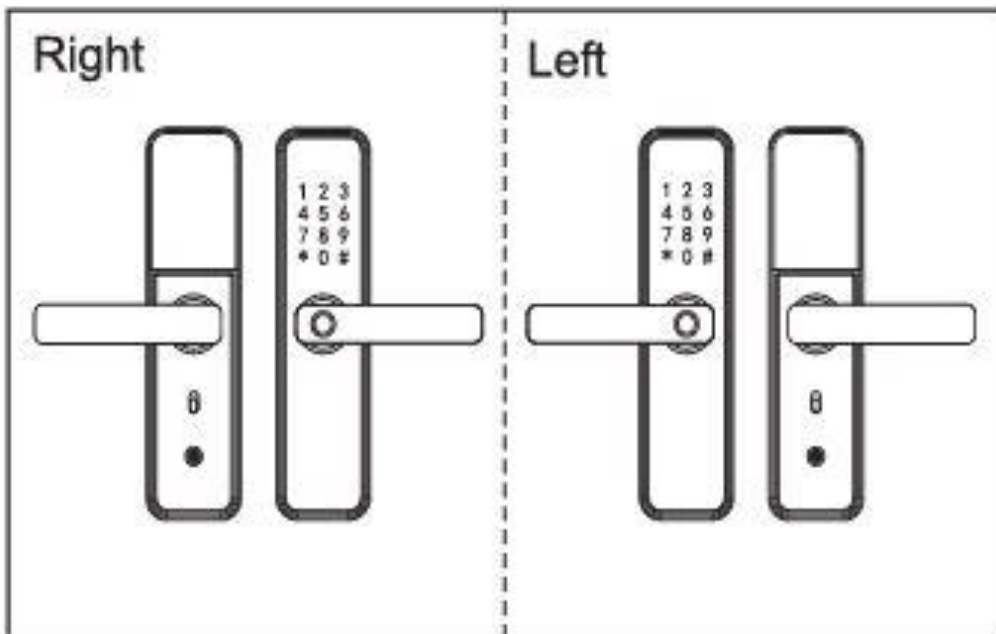

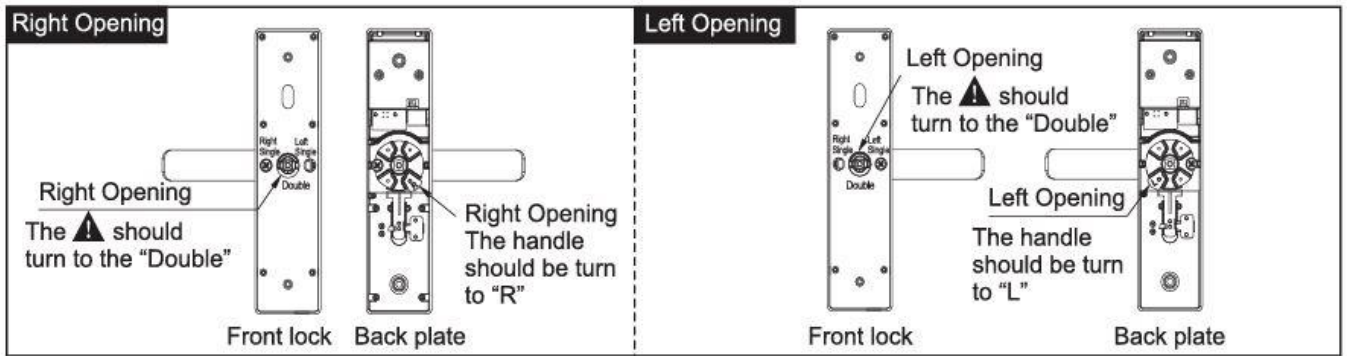

## Adjusting the direction of the groove

Depending on your needs, adjust the direction of the drain.

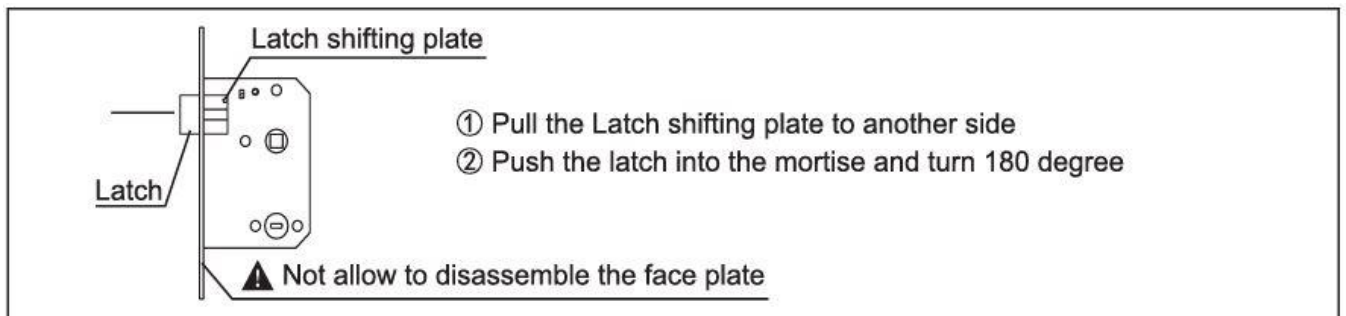

## Accessories for doors of different thicknesses

Available door thickness 35 mm - 55 mm. Choose the right accessories according to the thickness of the door.

Code and name	Specifications(mm)	door thickness ranges & QTY	
		35≤M≤40(mm)	41≤M≤55(mm)
⑥ Spindle 80(mm)		1	1
⑩ Screw 4.2X25(mm) (wood door only)		4	4
⑩ Screw M4X30/ 45(mm)		1	
		1	2
② Connecting pillar 30/35(mm)		1	
		1	2



# Pre-Installation Considerations



Do not use much force during installation to avoid damage to the lock.



Be sure to use the correct assembly tools.



Wear safety goggles when drilling holes.

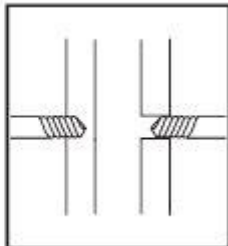
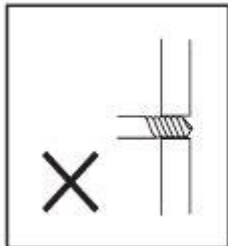

Drilling holes in the door on both sides of the door avoids damaging the door plate.

# Installation

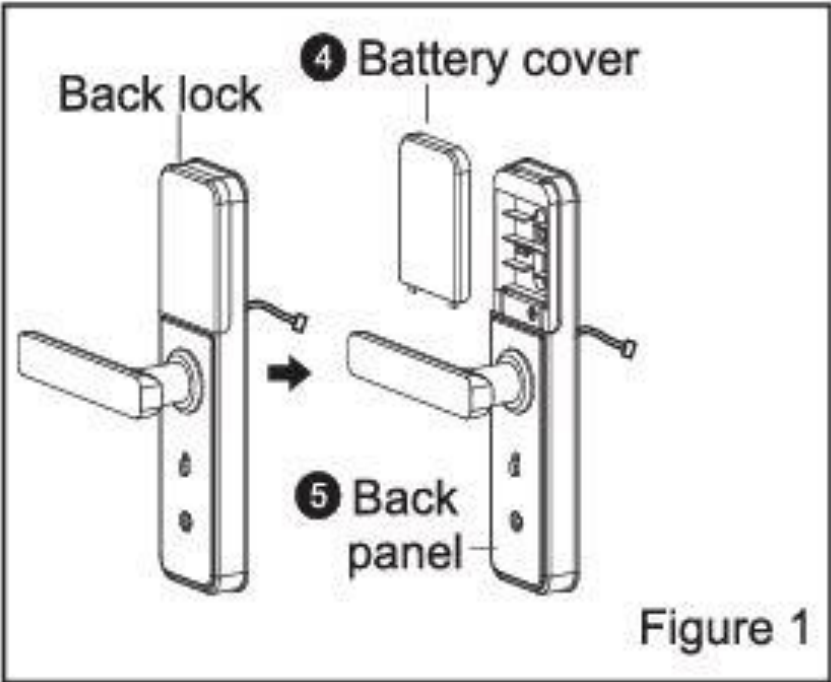

- (1) As shown in Figure 1: Divide the rear lock into the battery cover and the back panel.

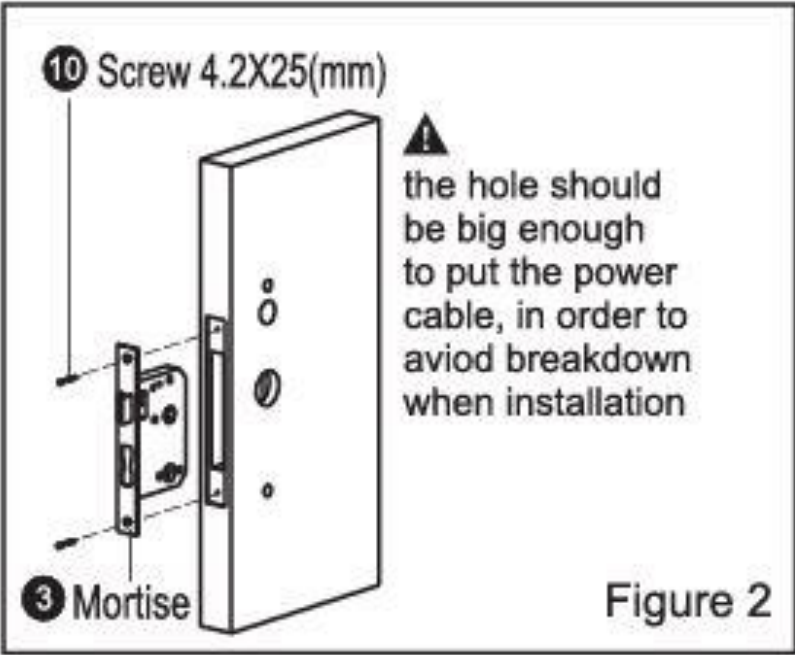

- (2) According to Figure 2: Feed the cable through the door plate, fix the keyway with 2 screws.

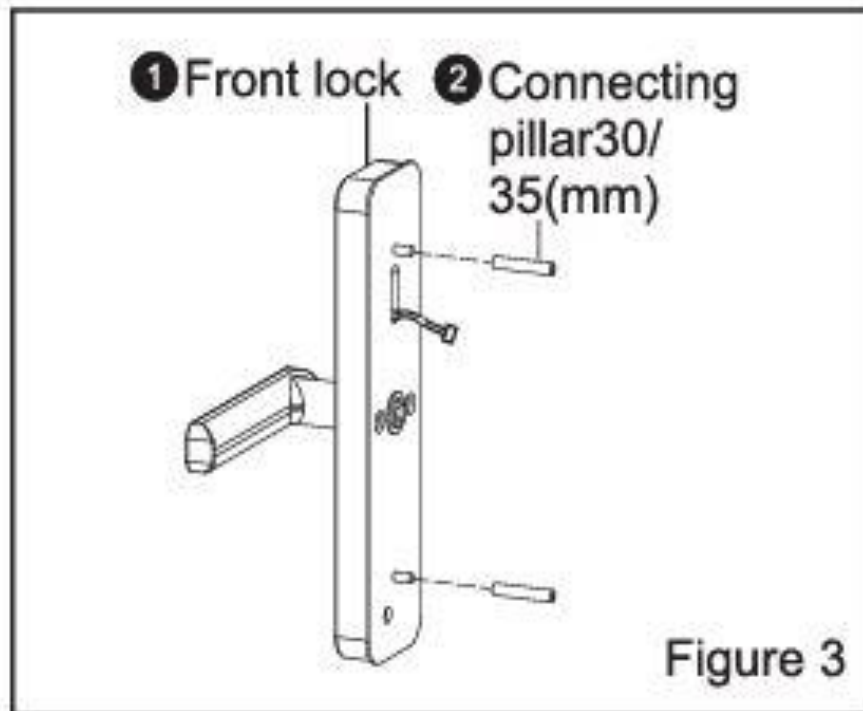

Figure 3

- (3) According to Figure 3: Fix the two connecting posts on the front panel.

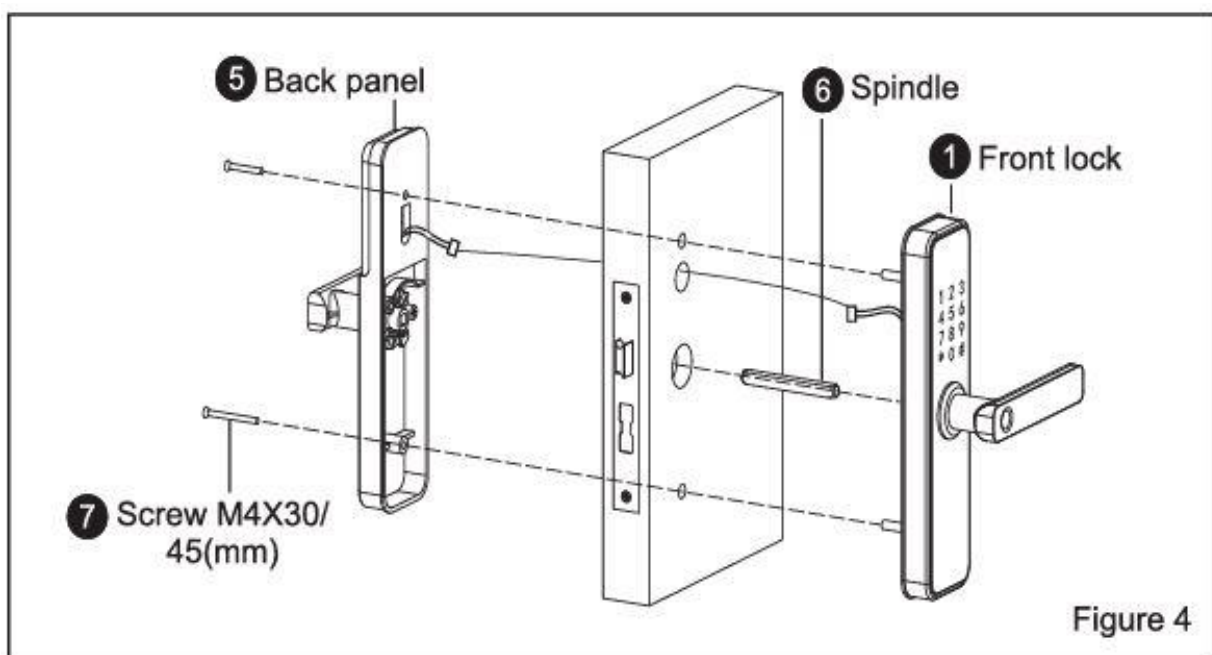
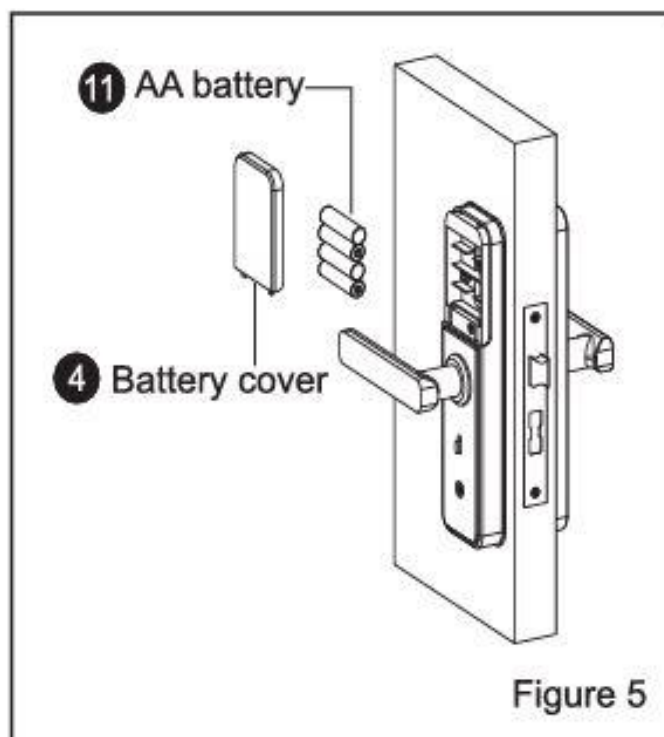

Figure 4

- (4) According to Figure 4:
- Place the mandrel in the groove
  - Route the cable from the front panel to the door plate and to the rear panel

- Fix the front panel and back panel with two screws



- (5) According to Figure 5: Insert the batteries correctly and fix the battery cover

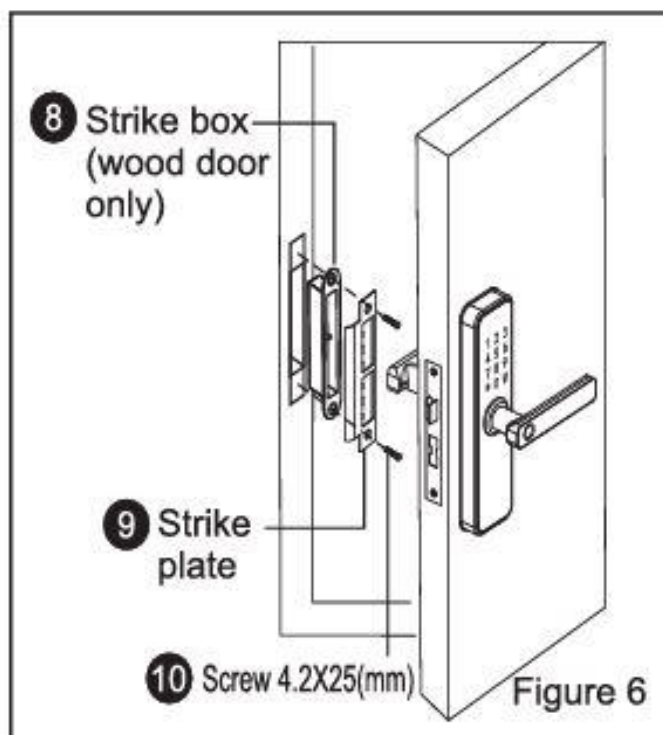

(6) According to Figure 6:

- Install the strike box and strike plate onto the door frame with 2 screws
- Check if the lock is working properly

## Points to check after installation

1. The faceplate is horizontal to the door.
2. Latch deadbolt, deadbolt and security deadbolt work smoothly and flexibly
3. The front zipper is vertical and stable

## Smart Lock User Manual (Five in One)

### 1. Function & Operation

#### a) Description of terms and function buttons

- **Administrator information:** Fingerprint, password, or admin IC card. **Unlock information:** refer to the fingerprint, password, remote control, or IC card information entered (including administrator and ordinary users).
- **\* key:** Wipe key/ Undo key. Enter the password or point, deleting the previously entered data. Press the erase button three times in a row to clear all entered data.
- **# key:** Confirm button or menu function button

### 2. Initial state

- The factory administrator password or initial password is 123456, in the initial state, the lock can be opened by fingerprint, IC card or password.

- Fingerprint, IC card or password that has not been registered cannot open the lock after entering the administrator information.

### 3. Managing the Lock Function

- Press\*
- and then press #
- After the voice prompt, enter the admin details (enter 123456 #)
- When the operation is completed successfully, you will hear the voice prompt again, then press 1 for administrator settings, press 2 for user settings, press 3 for system settings, press 4 for factory reset.

### 4. Setting the Administrator

#### Adding an administrator:

- select **Manage lock features**
- After the voice prompt, select 1 for admin settings, select 2 for user settings
- press 1 to add administrator, enter fingerprint or password (need to enter fingerprint four times, password 4-8 digits twice (e.g. 8888#), IC card one time)
- Once successfully entered, press \* to return to the previous level to continue adding an administrator or removing an administrator

#### Delete admin information

- select **Manage lock features**
- After the voice prompt, select 1 for admin settings, select 2 for user settings
- enter the number, press # to confirm (for example, 002#)

- Once successfully entered, press \* to return to the previous level or continue with adding an administrator or removing an administrator

## 5. Typical User Setting

### 1) Add admin information

- select **Manage lock features**
- After the voice prompt, press 1 for admin settings, press 2 for user settings
- Press 1 to add user, press 2 to remove user
- press 1 to add a user, enter the information of how to unlock, such as fingerprint, password (need to enter fingerprint three times, enter password 4-8 digits twice, or IC card one time).

### 2) Deleting User Information

- select **Manage lock features**
- After the voice prompt, press 1 for admin settings, press 2 for user settings
- Press 1 to add user, press 2 to remove user
- Press 1 to delete a number, press 2 to delete all. For example, press 1 and then enter a number (010#) to remove user 010

## 6. System Settings

### 1) Voice settings

- select **Manage lock features**
- Press 1 for admin settings, press 2 for user settings
- Press 1 for voice settings, 2 for unlock mode, 3 for language settings, 4 for time settings
- Press 1 to open voice settings, press 2 to close voice settings. After selecting, you will be informed if the operation was successful.

## 2) Unlock Mode Setting

- select **Manage lock features**
- Press 1 for admin settings, press 2 for user settings
- Press 1 for voice settings, 2 for unlock mode, 3 for language settings, 4 for time settings
- Press 1 for single mode, press 2 for combination mode.  
Press 3 to turn on the transition mode, press 4, when the operation is completed successfully, you will be informed by a voice prompt

## 3) Language settings

- select **Manage lock features**
- Press 1 for admin settings, press 2 for user settings
- Press 1 for voice settings, 2 for unlock mode, 3 for language settings, 4 for time settings
- The current time is 1908080808, then press # to enter the current time. Modify the time (year-month-day-hour:minute format, for example: 1903041153), then press # to confirm.

## 4) Factory reset

- select **Manage lock features**
- Press 1 for admin settings, press 2 for user settings
- Enter admin details (e.g. 123456) Press # to confirm
- Successful initialization

## App configuration (TUYA Smart) – optional

1. Search for Tuya Smart in App Store or Google Play, download and install.
2. Register with your mobile number and log in.
3. Click Security, find Lock (Wi-Fi), click and add a device.



## Adding a single network

- Press \* and # to authenticate the admin identity, then press 1 to access the admin settings. A voice prompt will then appear informing you that you need to select the 3 key to configure the network.
- Press 1 to connect to the hotspot and 2 to get a smart connection.
- When the network is successfully added, the 1st, 2nd, 3rd and 4th indicator light will illuminate, which will confirm the voice prompt informing you that the operation is complete
- If the network addition fails, lights 1, 2, 3 and 4 on the keypad will not illuminate, and a voice message will be emitted when the timeout occurs, informing you that the operation has failed.

**Note:** Before setting, add an administrator.

## Other considerations

1. Entering the wrong password more than 5 times in a row will lock the keypad for 30 seconds. The device will not respond to any operation within 30 seconds.
2. Password peeping prevention function: enter the password as follows when opening the door: XXX password XXX. You can add additional codes before and after the password, and then you should press # to confirm. The password must be included in the input body.
3. If no operation is performed for more than 10 seconds, the system will automatically terminate.

4. When the voltage is below 4.6V, the lock will automatically alarm every time it is opened. Once the alarm is triggered, the lock can be opened about 200 times.
5. After removing the battery cover and pressing the Set key for 6 seconds, the lock will be restored to factory mode.
6. In factory mode, you can quickly change the language after typing 333666999#.
7. When unlocking, type \* to call the user's number by voice.
8. When unlocking, enter 5# to enter transition mode (effective once)
9. Once the electronic lock is locked, only the administrator can open the lock again.

## Smart Lock User Manual

### Main Functions

1. Registration and login to the TUYA application
  - **In-app registration:** If you don't have an in-app account, you can sign up or log in using an SMS verification code.
  - Click **Create a new account** to go to the account registration page. According to the information about getting the SMS verification code, set a password.
  - If you already have an account, click **Sign in with an existing account** to sign in to the app. Password, verification code, and social account login are supported.

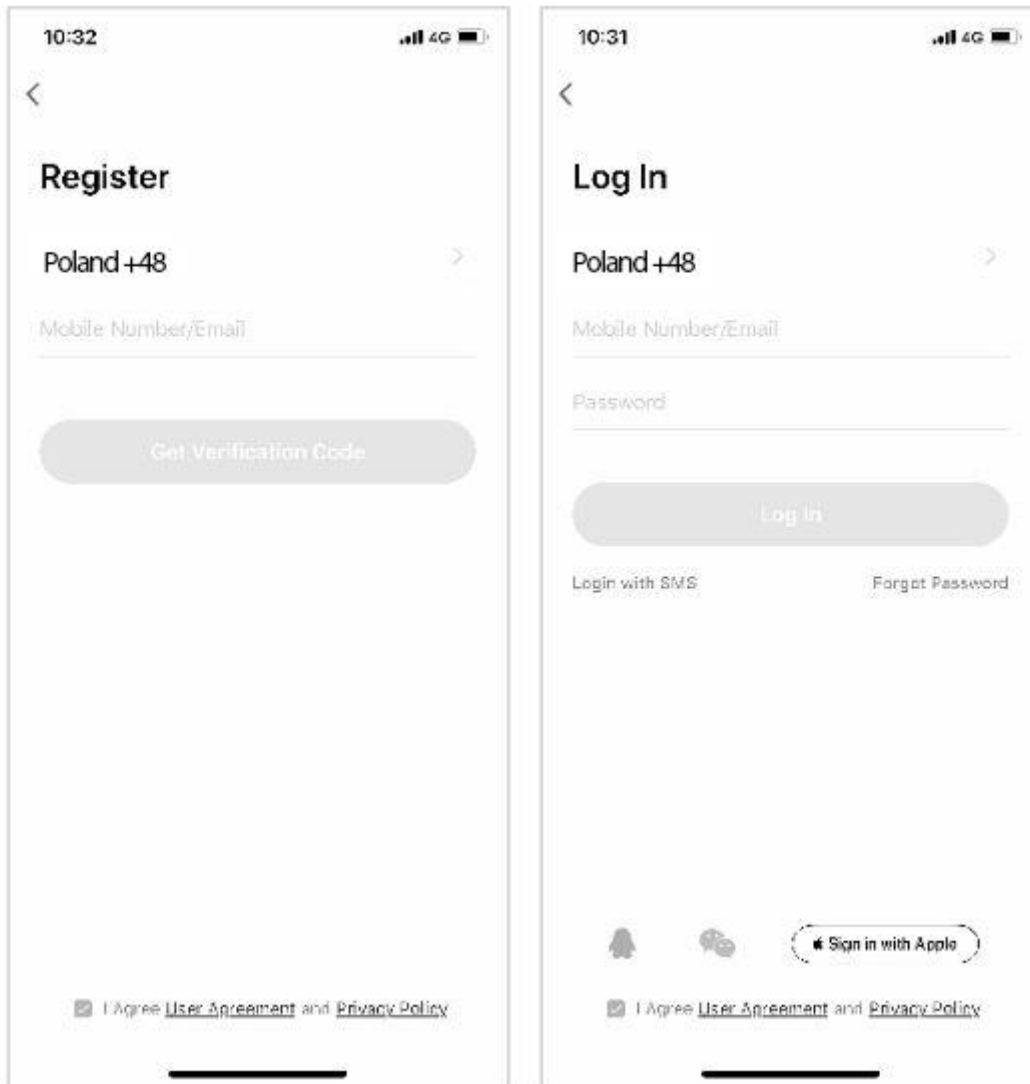

## 2. Creating Houses and Rooms

- Once you have successfully registered and logged in, you need to add the place where the smart handle has been installed in the app to be able to control the electronic lock.
- Multiple buildings can be created and added to each account, and mounted devices can be grouped by room.

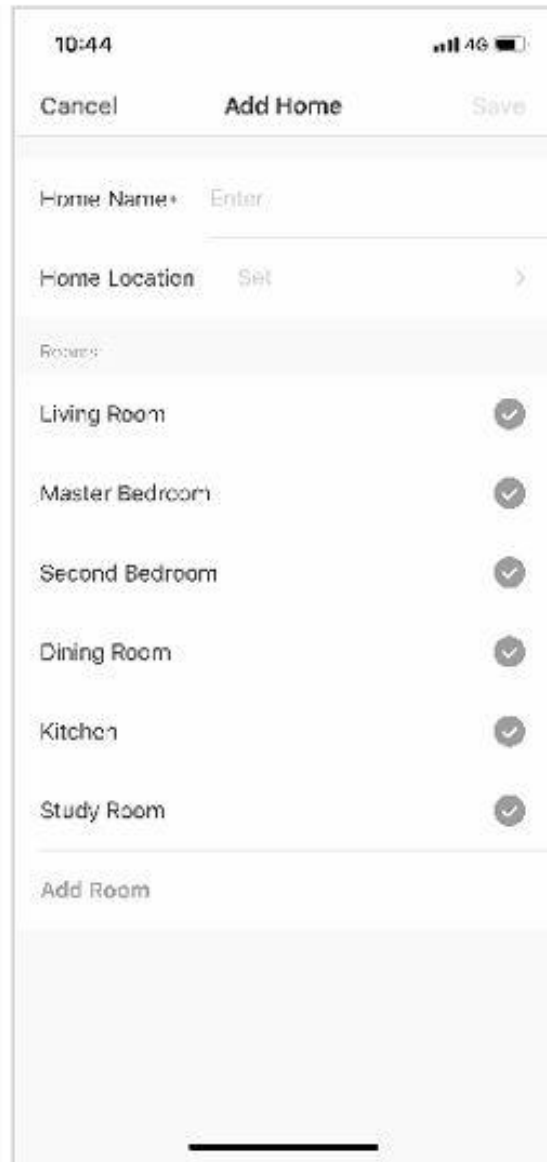

### 3. Adding a WiFi Lock

- On the **My Home tab**, click the **+** button in the upper right corner to enter the interface shown in Figure 1, select the **WiFi door lock** in the security sensor part, and go to the page shown in Figure 2.
- Once the device enters connected mode, continue to follow the instructions and directions of the app.



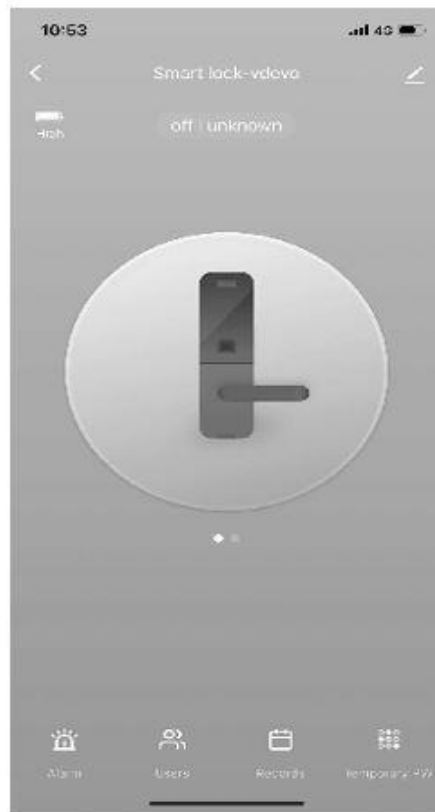

## 5. Dynamic Password

- Click Dynamic **Password** and copy the password text

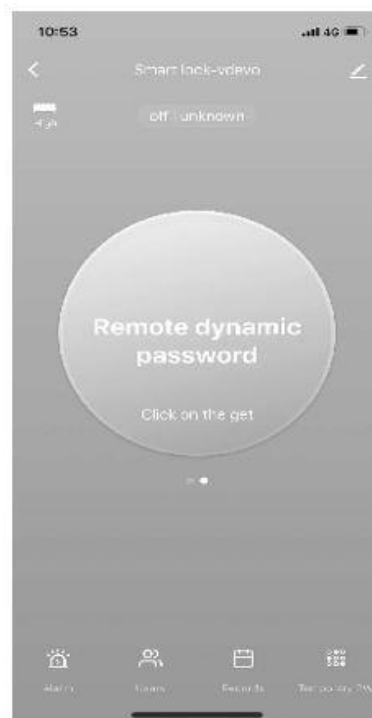

## 6. Message Center

- The message center contains information about the alarm, doorbell, and tamper alarm that can be triggered.



## 7. User management

- You can add, remove, or change a user's information in the User Management tab. Only the application administrator can make changes.

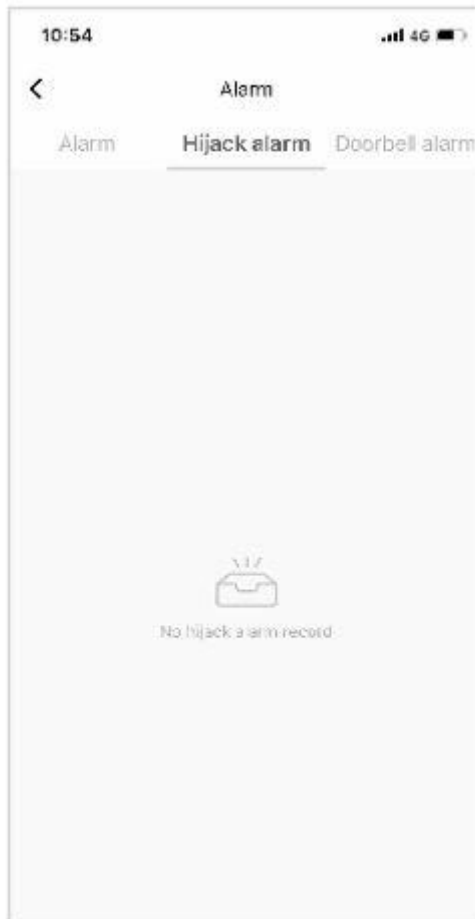

## 8. Log Log

- The 24/7 register is arranged in reverse chronological order. An unlocked ID with an associated username will display the username directly, while an unlocked ID without an associated name will display the specific unlock ID.



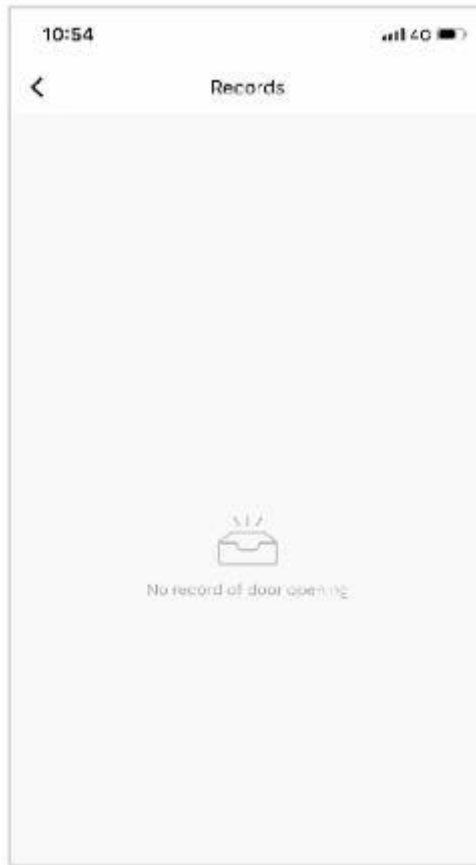

## 9. Temporary Password

- A temporary password can be created and deleted using the app. Each time a password is created or deleted in the app, the locking hardware must be synchronized with the server.
- At the time of creating a password, you can choose whether you want to send texts or not. SMS messages from all over the world are supported.

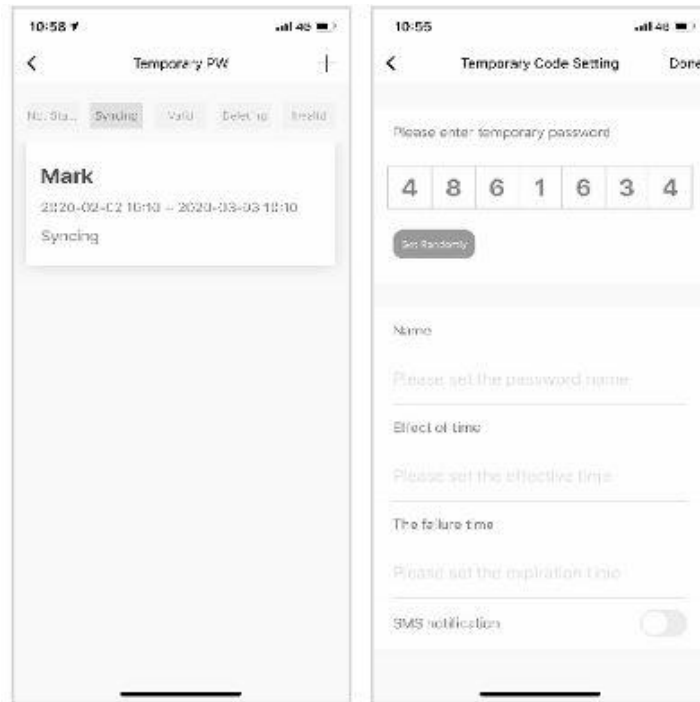

## 10. Interception Alarm

- On the interceptor alarm tab visible in the image, when the alarm is activated and the lock unlocking action occurs, the action will be reported and the app will trigger the interception alarm.

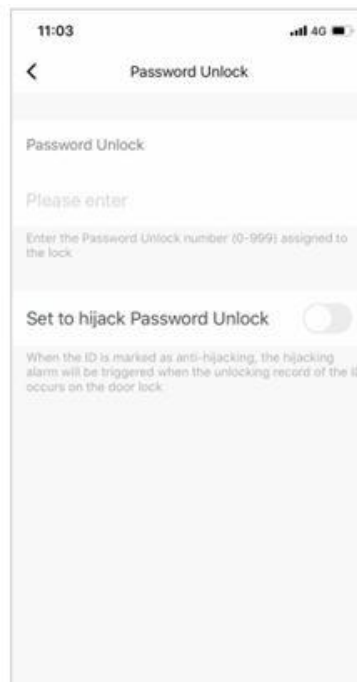

## 11. Factory reset

- Click the icon on the top right corner of the main interface. Find the Factory Data Reset option and click on it.
- Factory reset can also be operated from the electronic lock. For details, please refer to the user manual.

