

# User Manual

---

## Desk Lamp **LumixDesk-02**

# Table of contents

- Specifications: ..... 3
- Set contents:..... 4
- Features: ..... 4
- Installation Guide ..... 5
- Touch Control Panel..... 6
- Attention .....7

## Specifications:

- **Warranty:** 1 year
- **Colour:** Black, powder coated
- **Material:** PC, ABS, Aluminum Alloy, Iron
- **Luminous Flux:** 1300 Lumens
- **Color Temperature:** 3000K-6000K±275K
- **Lamp life:** 40,000 hours
- **Light Source:** LED
- **Additional functions:** brightness adjustment, light temperature adjustment
- **Mounting Method:** Clamping Screw
- **Power supply:** 100~240V 50/60Hz, 0.8A
- **Power:** 24W
- **Cable length:** 2 m
- **Ingress protection:** IP20
- **Operating temperature:** -10°C~+45°C
- **Operating Humidity:** 0%~85%
- **Product dimensions:** 105 x 88 cm
- **Package dimensions:** 45 x 28 x 9 cm
- **Product Weight:** 1.3kg
- **Product weight with packaging:** 1.45 kg

## Set contents:

- LumixDesk-02 lamp,
- AC adapter.

## Features:

- **Light Source (DIN):** LED
- **Brightness:** 1300 lumens
- **Lamp life:** up to 40,000 hours
- **Functions:** brightness adjustment, light temperature adjustment





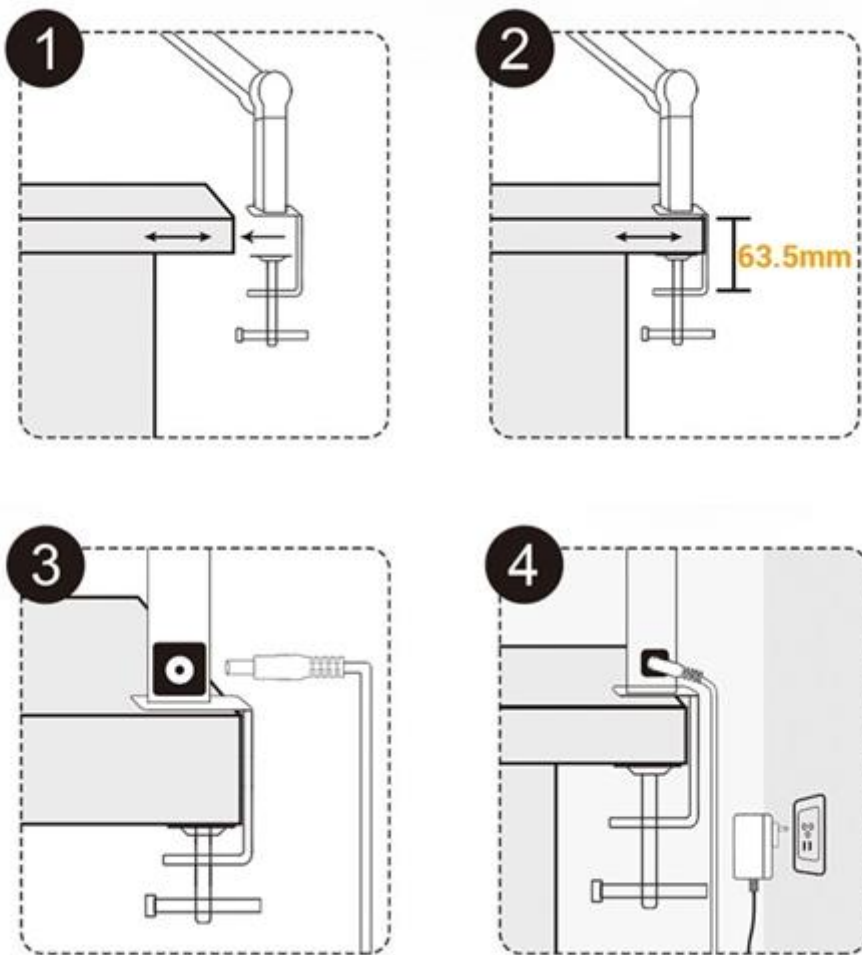

## Installation Guide

1. Install the clip in a suitable area.
2. Attach the clamp to the edge of your desk and then firmly secure the screw. Tabletop thickness should not exceed 6.35 mm.
3. Connect the supplied adapter to the desk lamp.
4. Plug the AC adapter into the power socket.



## Touch Control Panel



	Click: Turn on/off the main light in the middle.
	Ambient light sensor: The sensor receives ambient light and converts it into an electrical signal.
	Click: 5 levels of color temperature adjustment (3000K-3500K-4000K-5000K-6500K) Long press: Stepless tempering (3000-6500K)
	Click: 5 brightness levels adjustment (20%-40%-60%-80%-100%) Long press: Stepless dimming (20%-100%)
	Automatic light-sensing function indicator: When the automatic light-sensing function is turned on, the blue indicator light will be on; when the automatic light-sensing function is turned off, the blue light will be off.
	Click: Turn on/off the auxiliary lights on both sides. Long press: The light sensor will detect the surrounding light intensity and auto adjust the brightness.

## Attention

1. Keep the lamp away from heat sources.
2. Do not immerse appliance, cords or plugs in water or other liquid to avoid electric shock.
3. Do not look at the LEDs directly to avoid damage to eyes.
4. Please do not remove the power plug with wet hands as it may cause electrical shock.
5. Any repairs to the appliance should be carried out by a qualified service person.
6. Under no circumstances should this appliance be modified.