

# User Manual

---

## Industrial Bluetooth WIFI QR Code Scanner With Docking Station **HD9100B**

## Table of contents

Specifications: .....	3
Kit contents.....	4
Adjusting the Docking Station .....	5
Master codes.....	6
Pairing via Bluetooth.....	6
Case settings .....	6
Pairing via radio communication .....	7
Beep settings.....	7
Vibration settings.....	8
Sleep time settings .....	8
Endpoint settings.....	9
Bitrate settings.....	9
Bluetooth connection settings .....	10
Barcode Transfer Modes.....	10
Hide start and end characters.....	11
Prefix and Suffix settings .....	14
Virtual COM connection setting .....	15
Appendix 1. Control characters.....	17
Appendix 2. Display signs.....	20

## Specifications:

- **Warranty:** 2 years
- **Light Source:** CMOS Sensor
- **Processor:** ARM Cortex 32-bit
- **Scanning method:** manual (push-button)
- **Scan confirmation:** light, sound, vibration
- **Scanning speed:** 500 scans per second
- **Error rate:** 1/5 million
- **Built-in Memory:** 16Mb
- **Memory capacity:** up to 50,000 code reads
- **Wireless communication:** 433MHz, Bluetooth 4.1
- **Wireless range:** 100 to 800 meters indoors, depending on environmental conditions, and up to 1200 meters in open areas for radio communication, up to 10-15 meters for Bluetooth communication
- **Battery Capacity:** 1800 mA
- **Charging Current:** 5V
- **Operating Current:** 1 A
- **Operating time:** up to 24 hours for 1D codes, up to 16 hours for 2D codes
- **Charging Time:** 4 hours
- **Standby Time:** 30 days
- **Interface:** USB
- **Drop resistance:** up to 1.5 meters
- **Device dimensions:** 18.5 x 7 x 10 cm
- **Docking station dimensions:** 18 x 10 x 7.5 cm
- **Package dimensions:** 19.5 x 22 x 8.5 cm
- **Device weight:** 590 g
- **Package weight:** 770 g
- **Operating temperature:** 0 to 40°C
- **Storage temperature:** 0 to 60°C
- **Moisture:** 5% to 95%

- **Readable 1D codes:** Codabar, Code 11, Code 93, MSI, Code 128, UCC/EAN-128, Code 39, EAN - 13, UPC-A, ISBN, Industrial 2 z 5, Interleaved 2 z 5 (ITF), Standard 2 z 5, Matrix 2 z 5
- **Readable 2D codes:** QR, DataMatrix, PDF417, Hanxin, Micro PDF417

## Kit contents

- QR Code Reader
- Docking station and stand in one
- USB cable
- Manual

# Adjusting the Docking Station

To change the position of the stand, detach one of the sides. Then set it in the target position and attach the side to the stand.

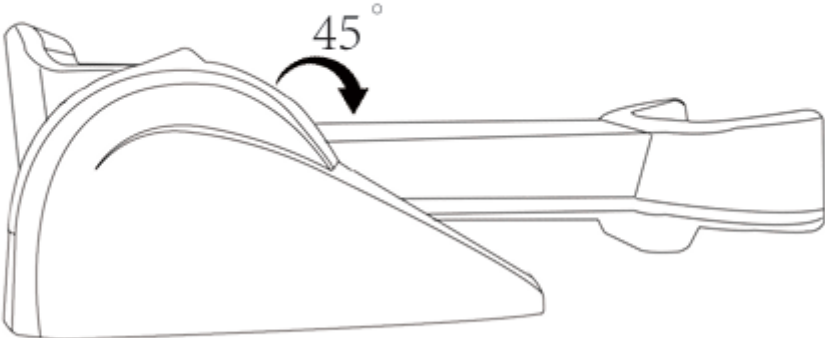
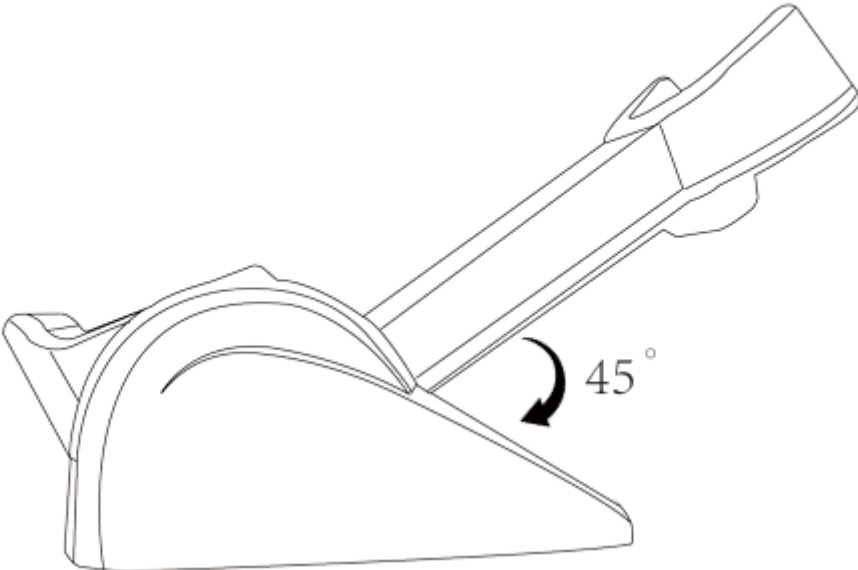

## Master codes



Restore to settings  
Factory



Software version



Battery level

## Pairing via Bluetooth

In order to pair the reader with any device equipped with Bluetooth technology, you must first scan the code below. The Bluetooth function must be enabled on the target device. Search for "BarcodeScannerHID" in the list of available devices and then click on it to pair the devices.



Pairing via Bluetooth

## Case settings



Lowercase



Uppercase letters



No case conversion



Case Conversion

## Pairing via radio communication

To set the reader to 443MHz mode, follow the steps below.

1. Scan the code below



2. Then you need to scan the code below.



3. Finally, connect the docking station to the USB port of your computer. A single beep indicates that the pairing is correct.

## Beep settings



Beep off



Beep on

# Vibration settings



Vibration off



Vibration On

# Sleep time settings



Sleep after 1 minute



Sleep after 5 minutes



Sleep after 10 minutes



Sleep after 30 minutes



Sleep off



Instant Sleep

## Endpoint settings



CR



LF



CR+LF



CR + LF cancellation



TAB

## Bitrate settings



High transmission speed



Average transmission speed



Slow transmission speed



Very slow speed

Transmission

## Bluetooth connection settings



Bluetooth HID



Bluetooth SPP



Bluetooth BLE

## Barcode Transfer Modes

- **Real-world mode**

Codes are sent directly to your computer immediately after scanning.



Real-world mode

- **Storage mode**

Scanned codes are saved in the built-in memory of the device, which can be later transferred to a computer.



Storage mode



Amount of data stored



Data transfer



Deleting data

Hide start and end characters



Hiding initial

## Characters



Hiding trailing characters

Number of characters to hide



1



2



3



4



5



6



7



8



9



10



11



12



13



14



15



16



Unhide starting characters



Unhide  
end characters

## Prefix and Suffix settings

### Display signs



Adding a prefix



Add a suffix

### Control characters



Character Set 0



Character Set 1



Character Set 2



Character Set 3



Character Set 4



Adding a prefix



Add a suffix



Cancel a prefix



Cancel a suffix

Virtual COM connection setting



Virtual COM





















### Pairing devices

**After scanning the two barcodes above, connect the docking station to the USB port of your computer.**

## Appendix 1. Control characters

1	SOH	NULL	Home	Ctrl+A	Alt+001	CR	
2	STX	Ctrl+B	End	Ctrl+B	Alt+002	Cap Lock	
3	ETX	Ctrl+C	Up Arrow	Ctrl+C	Alt+003	Right Arrow	
4	EOT	NULL	Down Arrow	Ctrl+D	Alt+004	Up Arrow	
5	ENQ	NULL	Left Arrow	Ctrl+E	Alt+005	NULL	
6	ACK	NULL	Right Arrow	Ctrl+F	Alt+006	NULL	
7	BEL	NULL	Shift+Tab	Ctrl+G	Alt+007	Enter	
8	BS	Back Space	Back Space	Back Space	Alt+008	Left Arrow	
9	HT	Tab	Tab	Tab	Alt+009	Tab	
10	LF	Enter	Enter	Ctrl+P	Alt+010	Down Arrow	
11	VT	NULL	NULL	Ctrl+Q	Alt+011	Tab	
12	FF	NULL	NULL	Ctrl+R	Alt+012	delete	
13	CR	Enter	Enter	Enter	Alt+013	Enter	

14	S0	F1	Page Up	Ctrl+N	Alt+014	Insert	
15	S1	F2	Page Down	Ctrl+O	Alt+015	Esc	
16	DLE	F3	F11	Ctrl+P	Alt+016	F11	
17	DC1	F4	NULL	Ctrl+Q	Alt+017	Home	
18	DC2	F5	NULL	Ctrl+R	Alt+018	Print Screen	
19	DC3	F6	NULL	Ctrl+S	Alt+019	Back Space	
20	DC4	F7	NULL	Ctrl+T	Alt+020	Shift tab	
21	NAK	F8	F12	Ctrl+U	Alt+021	F12	
22	SYN	F9	F1	Ctrl+V	Alt+022	F1	
23	TB	F10	F2	Ctrl+W	Alt+023	F2	
24	CAN	F11	F3	Ctrl+X	Alt+024	F3	
25	EM	F12	F4	Ctrl+Y	Alt+025	F4	
26	SUB	NULL	F5	Ctrl+Z	Alt+026	F5	
27	Esc	Esc	F6	Ctrl+[	Alt+027	F6	

28	FS	ALT+028	F7	Ctrl+\	Alt+028	F7	
29	GS	ALT+029	F8	Ctrl+]	Alt+029	F8	
30	RS	NULL	F9	Ctrl+^	Alt+030	F9	
31	US	NULL	F10	Ctrl+_	Alt+031	F10	

# Appendix 2. Display signs



!



#



%



,



)



+



Spacja



”



\$



&



(



\*



/



-



.



/



0



1



2



3



4



5



6



7



8



9



:



;



<



=



>



?



@



A



B



C



D



E



F



G



H



I



J



K



L



M



N



O



P



Q



R



S



T



U



V



W



X



Y



Z



[



\



]



^



-



,



a



b



c



d



e



f



g



h



i



j



k



l



m



n



o



p



q



r



s



t



u



v



w



x



y



z



{



|



}



~



DEL