

# User Manual

---

## Industrial Fixed QR Code Scanner HD360

## Table of contents

Specification: .....	3
Set contents: .....	4
Installation diagram.....	4
Output communication cables.....	5
Direct USB connection (with or without trigger) (HID; CDC).....	5
Direct RS232 connection (with / without trigger), used with 5V and 1A power supply.....	5
Split line version (support NG/OK control signal, support external trigger).....	6
DB/HDMI15 interface .....	6
Split USB cable and I/O connector.....	7
Split RS232 cable and I/O connection terminal.....	7
I/O connection port.....	7
DB9 serial port .....	8
Master Control Codes.....	9
Factory reset.....	9
Custom settings .....	9
Setting the detection sensitivity during scanning .....	10
Setting the time to read the repeated code.....	10
Decode time setting.....	12
Light signal settings.....	13
Illumination mode settings during scanning .....	13
Illumination intensity settings.....	14
Power beep settings.....	15
Decode beep settings .....	15
Communication settings.....	16
USB keyboard port .....	16
USB Virtual Serial Port.....	16
Serial port.....	17
Serial Port Baud Rate.....	17
Serial transmission of data bits .....	18

Serial port parity check character .....	18
Serial port stop bit.....	19
Barcode Scan Settings .....	19
Scan all barcodes .....	19
Scanning only 1D codes .....	20
Scanning only 2D codes .....	20
Disable scanning of all barcodes.....	20
Disable 2D Code Scanning .....	21
Setting the Prefix Initial Character.....	21
Setting the Suffix Trailing Character .....	23
Setting End Characters .....	<b>Błąd! Nie zdefiniowano zakładki.</b>
Case settings (CapsLock).....	25
Appendix 1. Numeric codes.....	26
Appendix 2. ASCII character table.....	27
Appendix 3. Function keys.....	59

## Specification:

- **Warranty:** 2 years
- **Material:** Aluminum
- **CPU:** ARM Cortex-A7, 1.2G high-performance CPU, MIPI interface
- **Resolution:** 1080 x 1280, high-performance sensor
- **Sensor Type:** CMOS
- **Light Source:** 10 Red LEDs
- **Scanning method:** automatically (when you bring the code closer)
- **Read acknowledgement:** light and sound signal
- **Scan Angle:** Horizontal 36° and Vertical 43°
- **Interface:** USB
- **Ingress Protection:** IP65
- **Power Supply:** DC5V
- **Operating temperature:** -10°C - 50°C
- **Storage temperature:** -40°C - 70°C
- **Operating Humidity:** 5%~95% (non-condensing)
- **Product dimensions:** 4 x 4 x 2 cm
- **Product weight:** 50 g
- **Weight with packaging:** 100 g
- **Odczytywane kody 1D:** UPC A, UPC E, EAN 8, EAN 13, Code 128, Code 39, Code 93, Code 32, Code11, Codabar, Plessey, MSI, Interleaved 2 of 5, IATA 2 of 5, Matrix 2 of 5, Straight 2 of 5, Pharmacode, RSS-14 , RSS-14 Expanded, RSS-14 Limited, Composite Code
- **Odczytywane kody 2D:** PDF 417, Micro PDF 417, Data Matrix, QR, Micro QR, MaxiCode

## Set contents:

- QR and barcode reader
- USB cable with plug for connecting external devices
- Manual

## Installation diagram

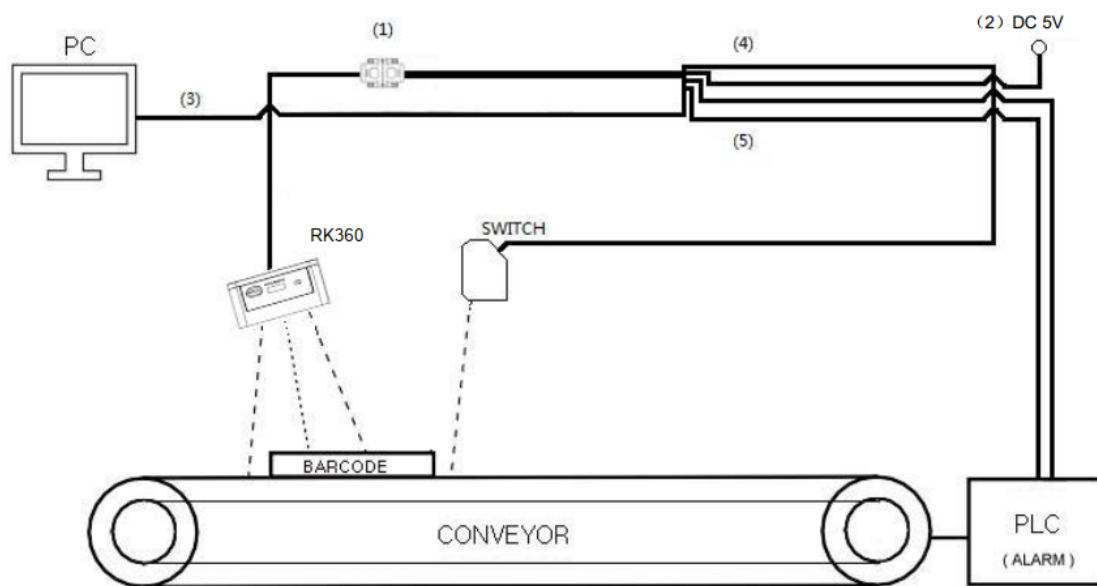

For the first use, please follow the diagram above to install and connect the barcode reader (using a custom I/O cable as an example).

(1) Split cable version: DB15 plug connector for connecting barcode reader and cable.

(2) Connect an external 5V DC power adapter.

(3) Connect the communication port to a PC or data acquisition terminal. RS232 and USB communication methods are supported.

(4) When using the "external trigger input mode", please connect the external sensor or PLC, etc.

(5) If the barcode reader is to output OK or NG read back, connect the NG/OK connector.

### Output communication cables

Direct USB connection (with or without trigger) (HID; CDC)

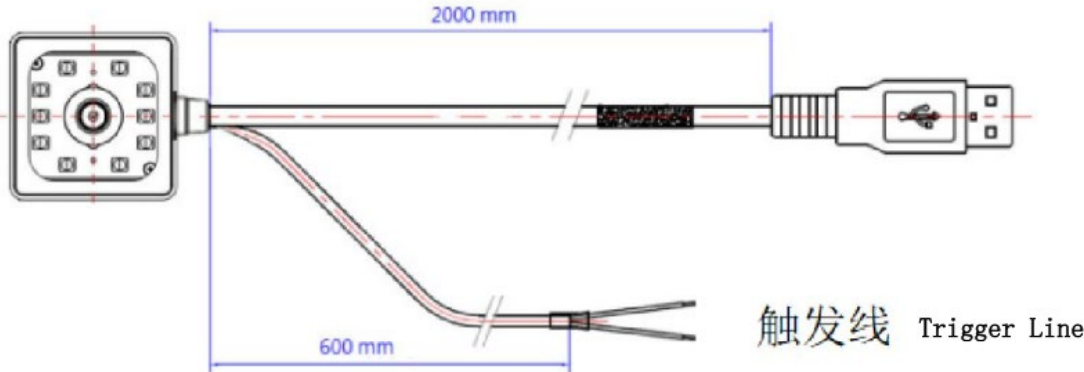

Direct RS232 connection (with / without trigger), used with 5V and 1A power supply

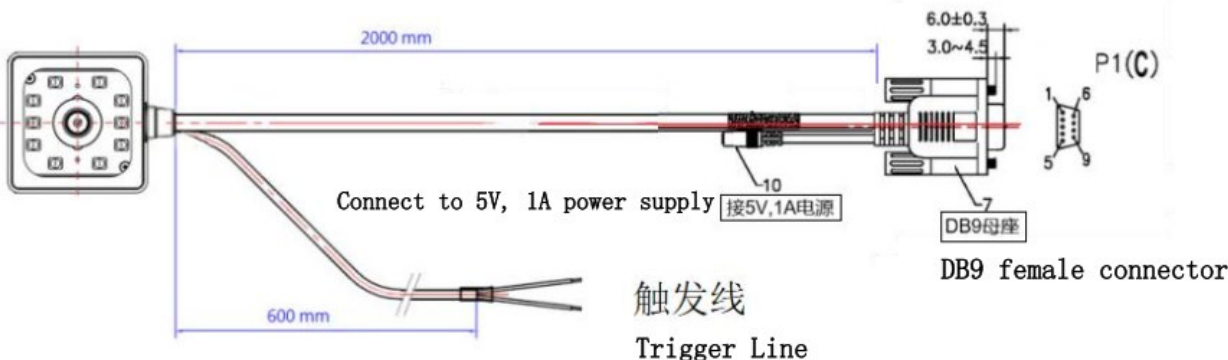

Split line version (support NG/OK control signal, support external trigger)

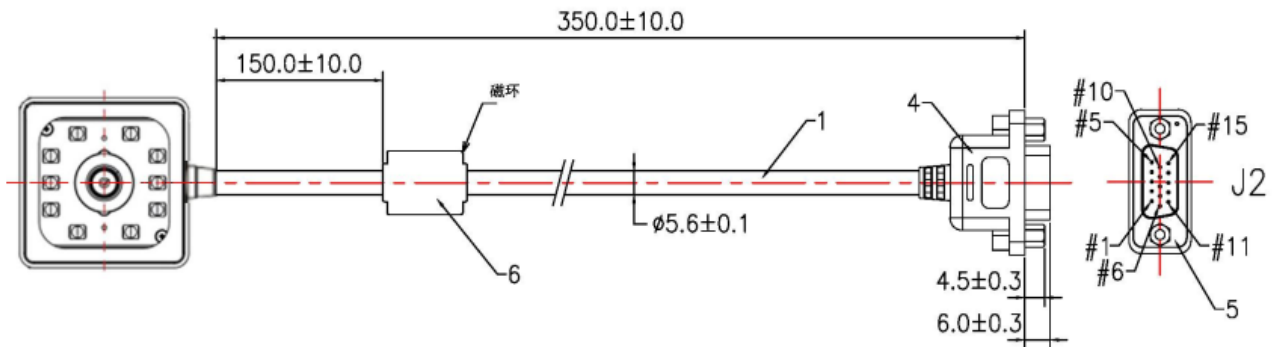

### DB/HDPI5 interface

J1/J2 (DB/HDP-15 pinów)	Definition
1	GND
2	- (empty)
3	- (empty)
4	D-
5	D+
6	TXD (Data Upload)
7	RXD (Receiving Data)
8	+5V
10	CTS (Send Clearance)
12	RTS (Send Request)
13	GND
14	External trigger
DB/HDP-15 pin metal housing	GND

## Split USB cable and I/O connector

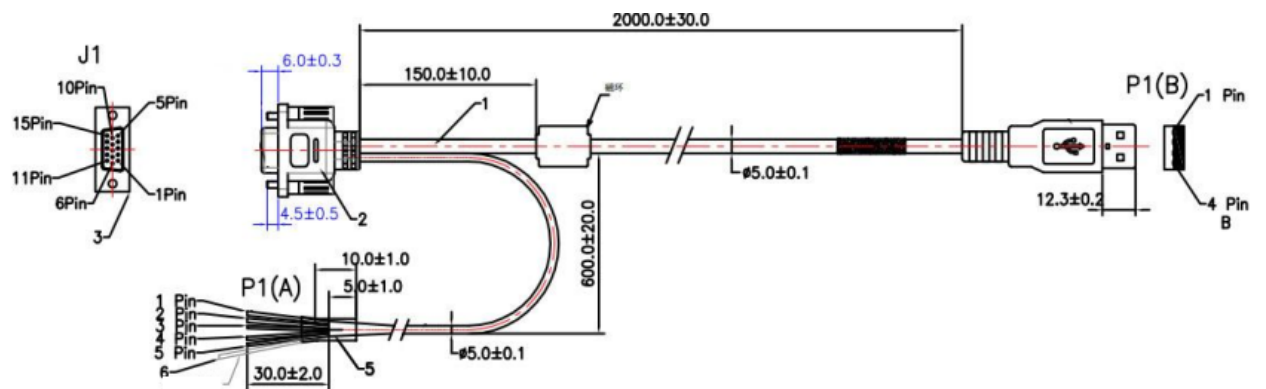

17

## Split RS232 cable and I/O connection terminal

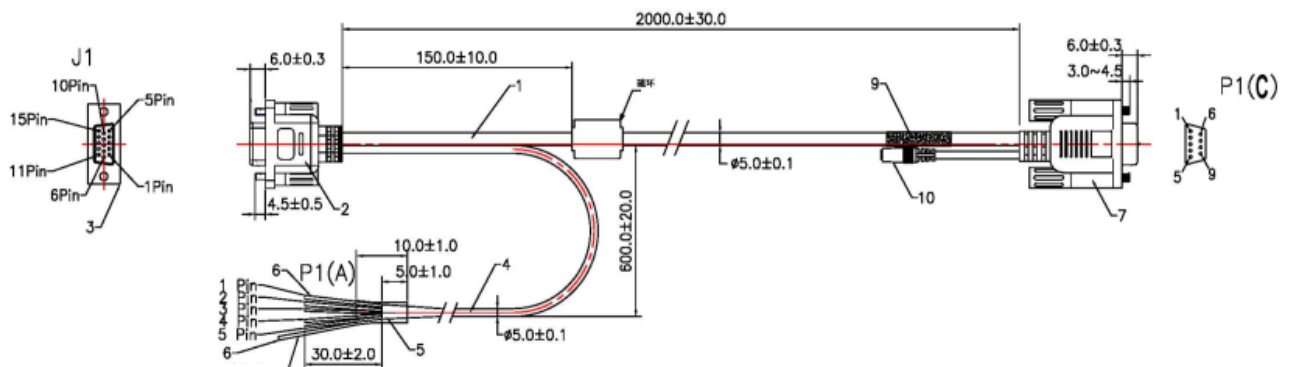

## I/O connection port

P1(A)(I/O port)	J1(DB-15 pinów)	Definition	Wire color
1	14	Trigger	Brown
2	6	GND	Black

3	2	Good reading	Green
4	3	Misreading	White
5	15	- (empty)	Red
6	15DB-15 metal terminal case	GND	



**Note:** The electrical requirements for the external input contact of the trigger are as follows: 5V input voltage 24V, and a maximum current not exceeding 15mA.

### DB9 serial port

PI(C) (port RS232)	Circuit Board	Definition
2	H1	TXD (Data Upload)
8	H2	RTS (Send Request)
3	H3	RXD (Receiving Data)
7	H4	CTS (Send Clearance)
5	H5	GND
shell	DB-9 Pin Metal Housing	wire braid

# Master Control Codes





## Factory reset

 Entering Setup Mode	 Factory reset
 Exiting Setup Mode	





## Custom settings

**Save custom settings:** Saves frequently used settings.

**Load Custom Settings:** Setting your saved custom settings.

 Entering Setup Mode	 Save settings as custom
 Loading custom settings	 Exiting Setup Mode

## Setting the detection sensitivity during scanning

 Entering Setup Mode	 Low sensitivity
 Medium sensitivity (default)	 High sensitivity
 Exiting Setup Mode	

## Setting the time to read the repeated code







This function allows you to set the time in which the repeated code will not be scanned again by the reader. By default, the same barcode will not be read multiple times within 500 milliseconds. The time can be set from 0 to 5000 milliseconds. 0 means no interval time, and thus repeating codes will be read every time.

To set the time when you don't want a repeating barcode to be read, follow these steps:

- Scan the "Entering Setup Mode" code
- Scan "No reading of repeated code in a specified time"
- Scan the code "Read Time Setting"

- Scan the corresponding numeric codes from the attachment at the end of the manual
- Finally, scan the "Exit Setting Mode" code

**Example:** To set the time when the reader does not scan a repeated code for 100 milliseconds, scan the codes "1", "0" and "0" from the attachment in sequence.

 <p>Entering Setup Mode</p>	 <p>No reading of repeated code within a specified time (default)</p>
 <p>Not reading the last scanned code</p>	 <p>Failure to read the last two scanned codes</p>
 <p>Setting the reading time</p>	 <p>Exiting Setup Mode</p>

## Decode time setting

The scanner offers the ability to set the decoding time. If the barcode is not read after the declared time has elapsed, decoding is disabled and the device goes into standby mode. The default value for the decode time is 3000 milliseconds. The range is from 0 to 3600000 milliseconds. 0 means continuous decoding until the barcode is read.



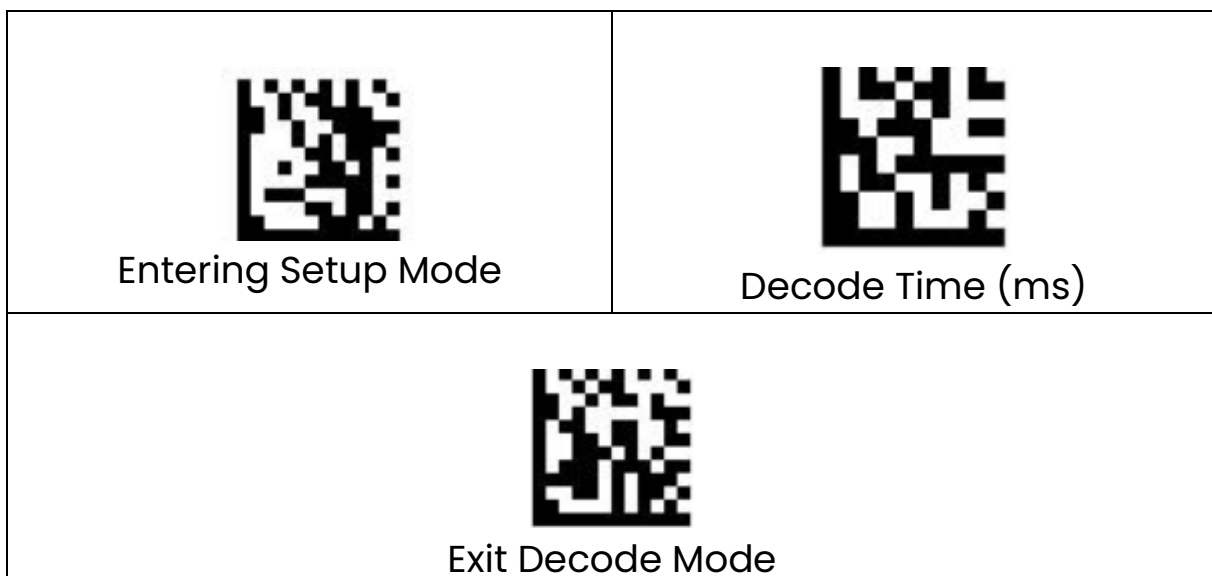

To set a specific decode time, follow these steps:

- Scan the **"Entering Setup Mode"** code
- Scan the **"Decode Time"** code
- Scan the numerical codes corresponding to the desired decoding time from the attachment at the end of the instructions in sequence.
- Finally, you should scan the **"Exit Configuration Mode"** code





**Example:** In order to set the decoding time to 5 seconds, scan the numeric codes from the attachment: "5", "0", "0", and "0".





# Light signal settings





 <p>Entering Setup Mode</p>	 <p>Light signal on all the time (default)</p>
 <p>Light signal on during scanning</p>	 <p>Light signal off all the time</p>
 <p>Exiting Setup Mode</p>	

# Illumination mode settings during scanning



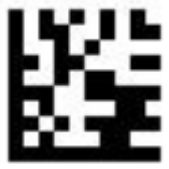

 <p>Entering Setup Mode</p>	 <p>Illumination enabled during scanning (default)</p>
 <p>Lighting on all the time</p>	 <p>Fade lighting</p>

 <p>Lighting off</p>	 <p>Exiting Setup Mode</p>
---	---





## Illumination intensity settings

 <p>Entering Setup Mode</p>	 <p>Low brightness</p>
 <p>Medium brightness</p>	 <p>High brightness (default)</p>
 <p>Exiting Setup Mode</p>	

# Power beep settings

 <p>Entering Setup Mode</p>	 <p>Beep on startup (default)</p>
 <p>Beep during startup off</p>	 <p>Exiting Setup Mode</p>

# Decode beep settings

 <p>Entering Setup Mode</p>	 <p>Beep during scan on (default)</p>
 <p>Beep during scan off</p>	 <p>Exiting Setup Mode</p>

# Communication settings

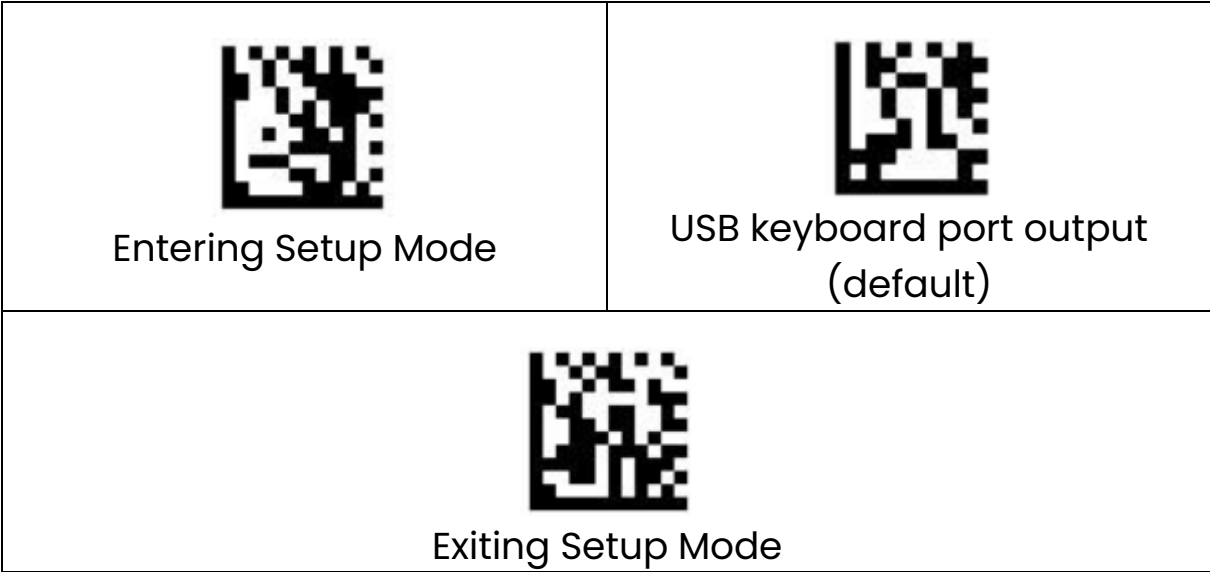

## USB keyboard port



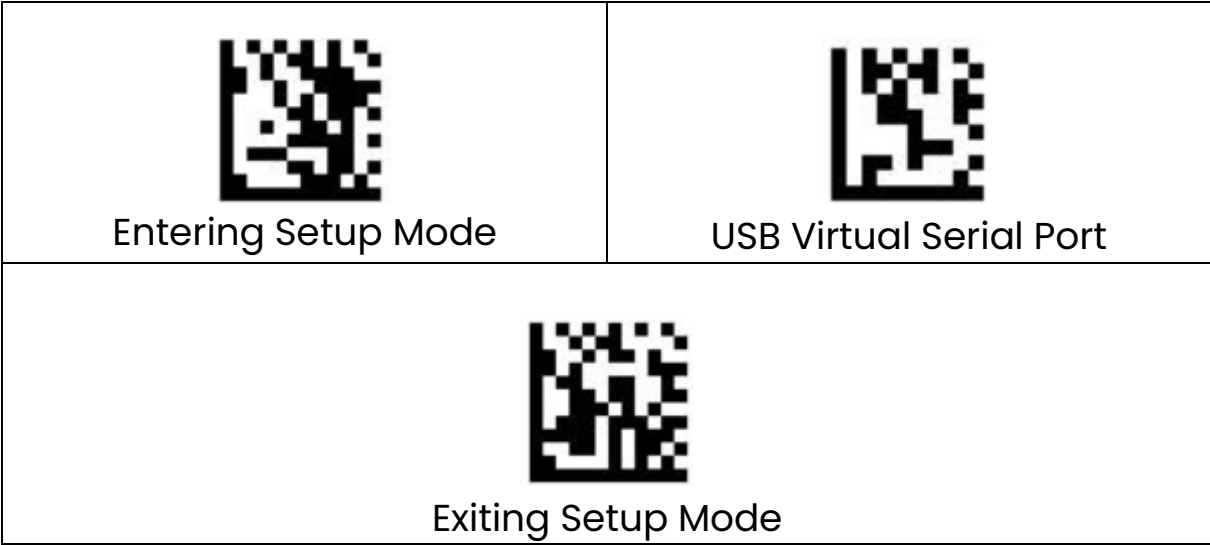







## USB Virtual Serial Port







Serial port

 Entering Setup Mode	 Serial port output
 Exiting Setup Mode	



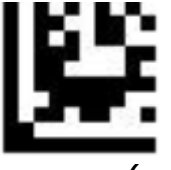

Serial Port Baud Rate

 Entering Setup Mode	 9600 (default)
 19200	 38400
 57600	 115200
 230400	 Exiting Setup Mode





Serial transmission of data bits

 <p>Entering Setup Mode</p>	 <p>7 bits of data</p>
 <p>8 bits of data (default)</p>	 <p>Exiting Setup Mode</p>

Serial port parity check character



 <p>Entering Setup Mode</p>	 <p>No check (default)</p>
 <p>Odd check</p>	 <p>Check</p>
 <p>Exiting Setup Mode</p>	

Serial port stop bit

 Entering Setup Mode	 One stop bit (default)
 Two alloy bits	 Exiting Setup Mode

Barcode Scan Settings

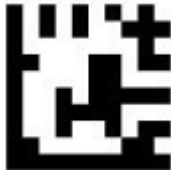
Scan all barcodes

 Entering Setup Mode	 Scan all codes
 Exiting Setup Mode	

Scanning only 1D codes

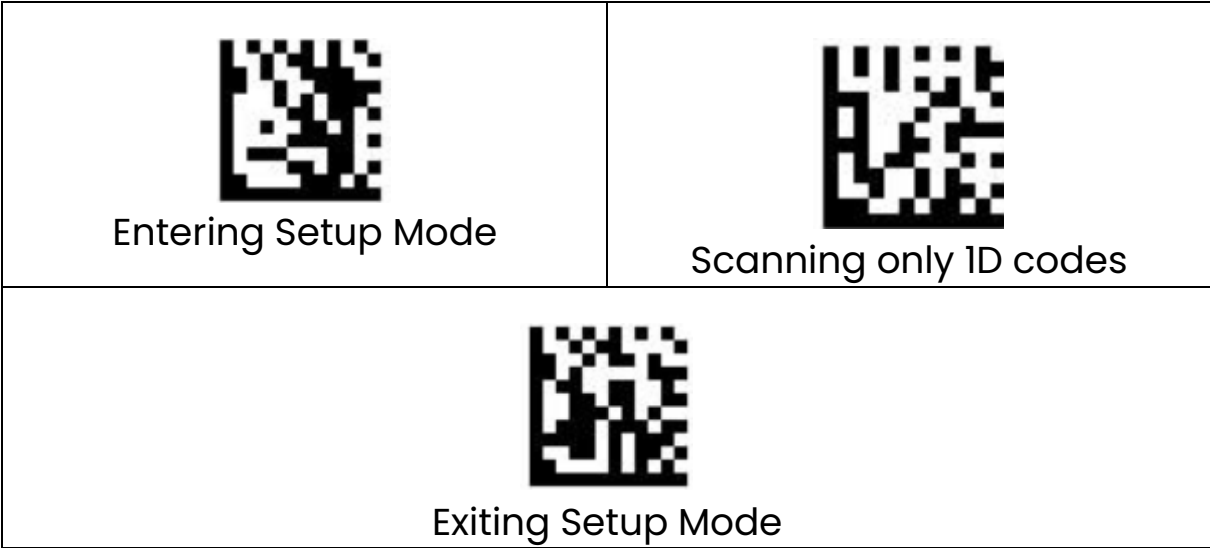

Scanning only 2D codes

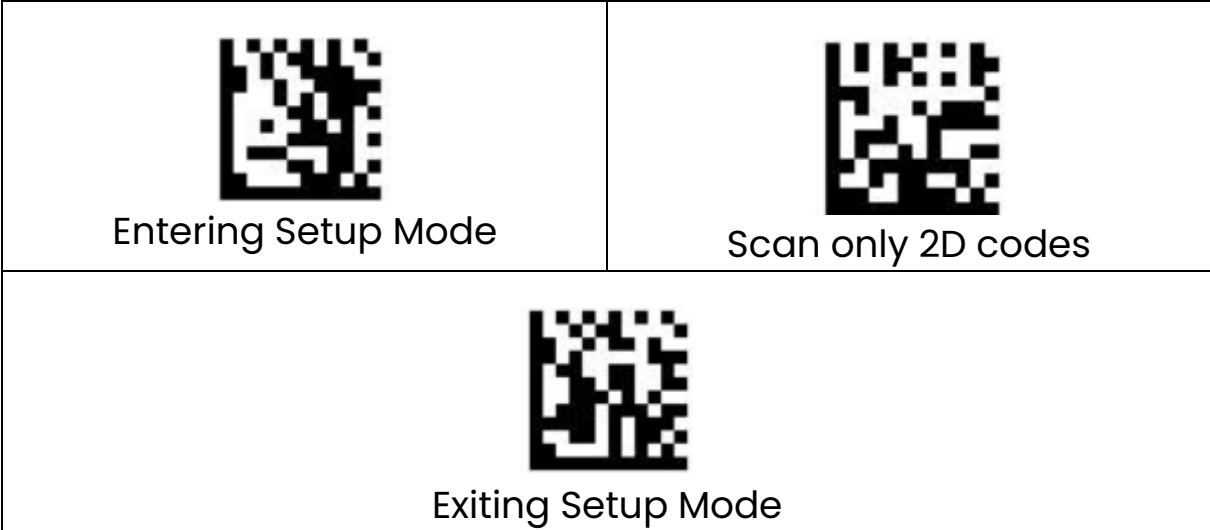

Disable scanning of all barcodes

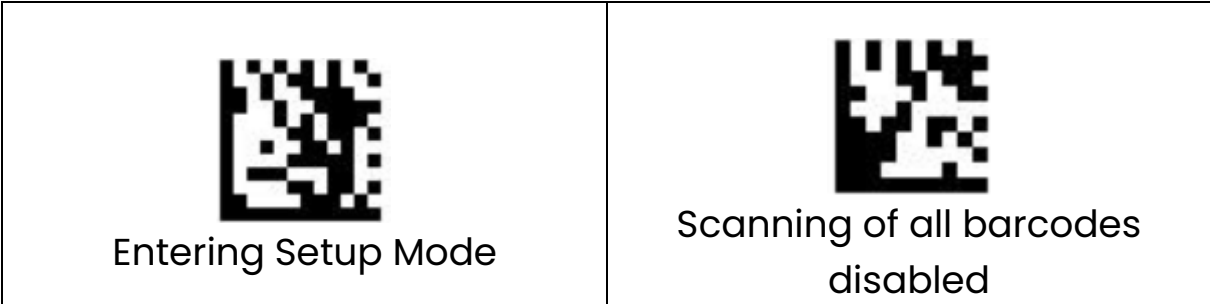



### Disable 1D Code Scanning

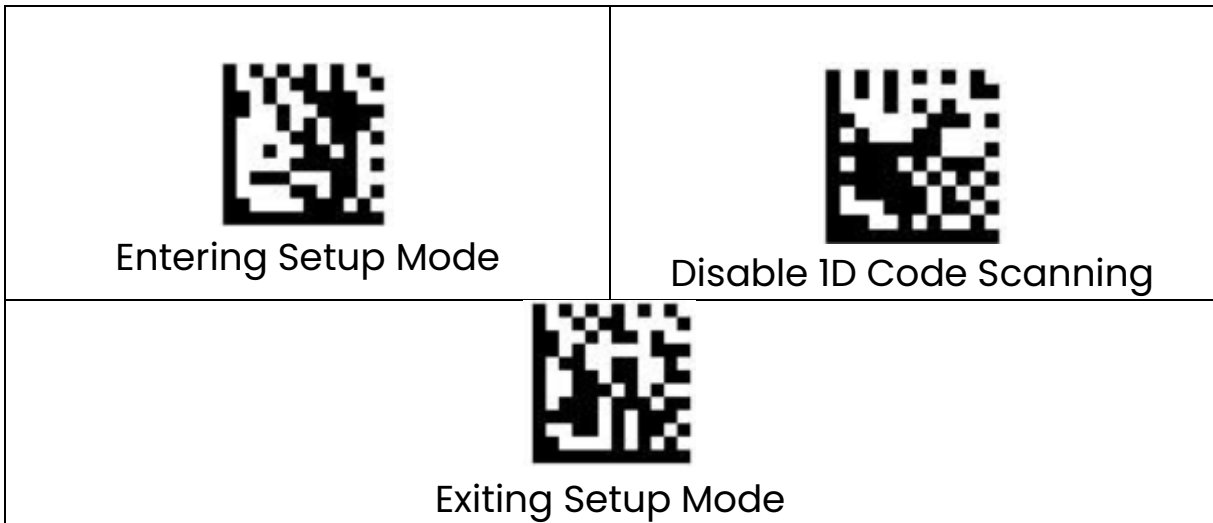

### Disable 2D Code Scanning

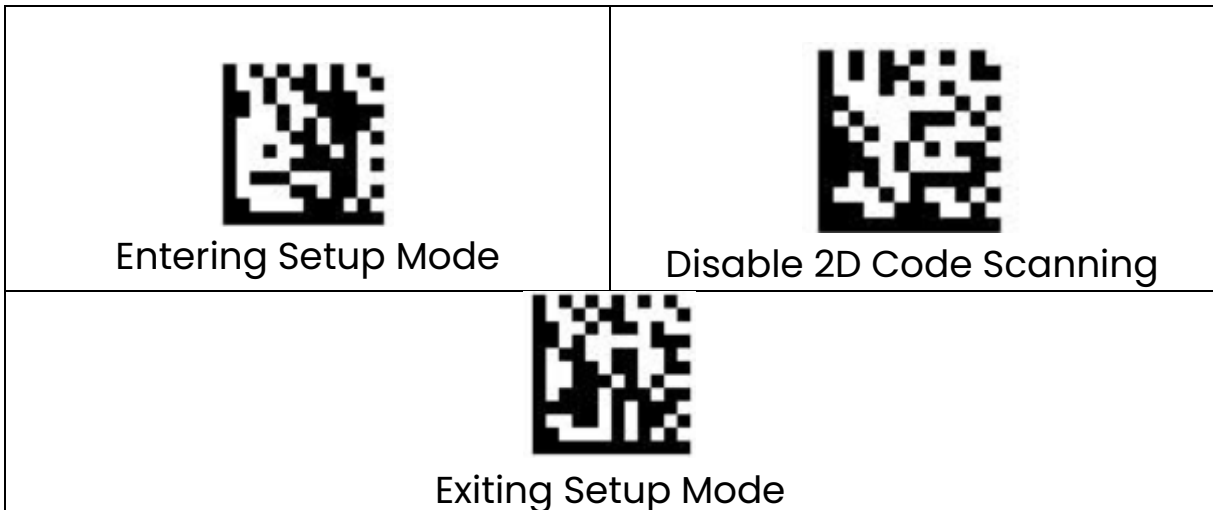

## Setting the Prefix Initial Character

You can add up to 4 characters before a barcode.

To enable all prefixes before the barcode, follow these steps:





- Scan the "Entering Setup Mode" code
- Scan "Setting all prefixes"
- Scan the appropriate code with the character to be prefixed in the ASCII Character Table attachment at the end of the manual
- Finally, scan "Exit Configuration Mode"

To remove all added prefixes , follow these steps:

- Scan the "Entering Setup Mode" code
- Scan the "Disable all prefixes" code
- Scan the "Exit Setup Mode" code

To add the initial character as a prefix before the barcode, follow these steps:

- Scan the "Entering Setup Mode" code
- Scan the "Barcode Prefix Setting" code
- Scan the appropriate code with the character to be prefixed in the ASCII Character Table attachment at the end of the manual
- Scan the "Exit Setup Mode" code
- 

 <p>Entering Setup Mode</p>	 <p>Disable all prefixes (default)</p>
 <p>Setting all prefixes</p>	 <p>Barcode prefix setting</p>

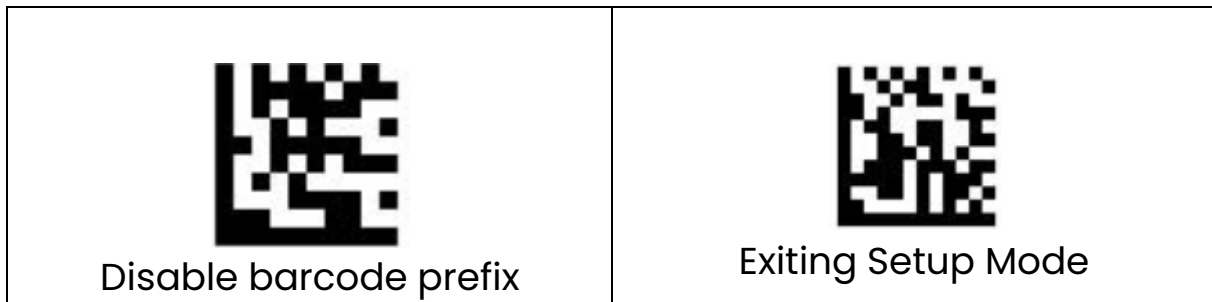

## Setting the Suffix Trailing Character

You can set up to 4 characters as the ending Suffix after the barcode.

To **enable all suffixes** before the barcode, follow these steps:





- Scan the **"Entering Setup Mode"** code
- Scan **"All Suffix Setting"**
- Scan the appropriate code with the character to be suffixed in the **ASCII Character Table attachment** at the end of the manual
- Finally, scan **"Exit Configuration Mode"**

To **remove all added suffixes** , follow these steps:



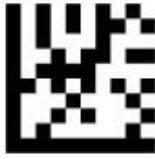
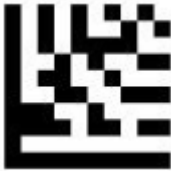

- Scan the **"Entering Setup Mode"** code
- Scan the code **"Disable all suffixes"**
- Scan the **"Exit Setup Mode"** code



To add an ending character as a suffix after a barcode, follow these steps:

- Scan the **"Entering Setup Mode"** code
- Scan the **"Barcode Suffix Setting"** code
- Scan the appropriate code with the character to be suffixed in the **ASCII Character Table attachment** at the end of the manual
- Scan the **"Exit Setup Mode"** code





 <p>Entering Setup Mode</p>	 <p>Disable all suffixes (default)</p>
 <p>Setting all suffixes</p>	 <p>Barcode Suffix Setting</p>
 <p>Disable barcode suffix</p>	 <p>Exiting Setup Mode</p>

## Setting End Characters

 <p>Entering Setup Mode</p>	 <p>No end sign</p>
 <p>CR (default)</p>	 <p>CR/LF</p>

 <p>TAB</p>	 <p>Exiting Setup Mode</p>
--	---

### Case settings (CapsLock)

 <p>Entering Setup Mode</p>	 <p>CapsLock disabled (default)</p>
 <p>CapsLock On</p>	 <p>Exiting Setup Mode</p>

Appendix 1. Numeric codes



0



1



2



3



4



5



6



7









8











9





# Appendix 2. ASCII character table





00 (NUL)	0	 NUL	Disable	Ctrl+@	Alt + 000
01 (SOH)	1	 SOH	Home	Ctrl+A	Alt + 001
02 (STX)	2	 STX	End	Ctrl+B	Alt + 002
03 (ETX)	3	 ETX	Up Arrow	Ctrl+C	Alt + 003





04 (EOT)	4	 EOT	Down Arrow	Ctrl+D	Alt + 004
05 (ENQ)	5	 ENQ	Left Arrow	Ctrl+E	Alt + 005
06 (ACK)	6	 ACK	Right Arrow	Ctrl+F	Alt + 006
07 (BEL)	7	 BEL	Null	Ctrl+G	Alt + 007





08	8	 BS	Backspace	Backspace	Alt + 008
09	9	 TAB	TAB	TAB	Alt + 009
0A (LF)	10	 LF	Null	Ctrl+J	Alt + 010
0B (VT)	11	 VT	Null	Ctrl+K	Alt + 011





0C (FF)	12	 FF	Null	Ctrl+L	Alt + 012
0D (CR)	13	 CR	Enter	Enter	Enter
0E (SO)	14	 SO	Page Up	Ctrl+N	Alt + 014
0F (SI)	15	 SI	Page Down	Ctrl+O	Alt + 015





10 (DLE)	16	 DLE	F11	Ctrl+P	Alt + 016
11 (DC1)	17	 DC1	Null	Ctrl+Q	Alt + 017
12 (DC2)	18	 DC2	Null	Ctrl+R	Alt + 018
13 (DC3)	19	 DC3	Null	Ctrl+S	Alt + 019





14 (DC4)	20	 DC4	Null	Ctrl+T	Alt + 020
15 (NAK)	21	 NAK	F12	Ctrl+U	Alt + 021
16 (SYN)	22	 SYN	F1	Ctrl+V	Alt + 022
17 (ETB)	23	 ETB	F2	Ctrl+W	Alt + 023





18 (CAN)	24	 CAN	F3	Ctrl+X	Alt + 024
19 (CAN)	25	 EM	F4	Ctrl+Y	Alt + 025
1A (SUB)	26	 SUB	F5	Ctrl+Z	Alt + 026
1B (ESC)	27	 ESC	F6	Ctrl+[	Alt + 027





1C (FS)	28	 FS	F7	Ctrl+\	Alt + 028
1D (GS)	29	 GS	F8	Ctrl+]	Alt + 029
1E (US)	30	 RS	F9	Ctrl+^	Alt + 030
1F (US)	31	 US	F10	Ctrl+_	Alt + 031





20	32	SPACE	
21	33	!	
22	34	"	
23	35	#	





24	36	\$	
25	37	%	
26	38	&	
27	39	,	





28	40	(	
29	41	)	
2A	42	*	
2B	43	+	





2C	44	,	
2D	45	-	
2E	46	.	
2F	47	/	





30	48	0	
31	49	1	
32	50	2	
33	51	3	





34	52	4	
35	53	5	
36	54	6	
37	55	7	





38	56	8	
39	57	9	
3A	58	:	
3B	59	;	





3C	60	<	
3D	61	=	
3E	62	>	
3F	63	?	





40	64	@	
41	65	A	
42	66	B	
43	67	C	





44	68	D	
45	69	E	
46	70	F	
47	71	G	





48	72	H	
49	73	I	
4A	74	J	
4B	75	K	





4C	76	L	
4D	77	M	
4E	78	N	
4F	79	O	





50	80	P	
51	81	Q	
52	82	R	
53	83	S	





54	84	T	
55	85	U	
56	86	V	
57	87	W	





58	88	X	
59	89	Y	
5A	90	Z	
5B	91	[	





5C	92	\	
5D	93	]	
5E	94	^	
5F	95	-	





60	96	,	
62	97	a	
62	98	b	
63	99	c	





64	100	d	
65	101	e	
66	102	f	
67	103	g	





68	104	h	
69	105	i	
6A	106	j	
6B	107	k	

6C	108	l	
6D	109	m	
6E	110	n	
6F	111	o	

70	112	p	
71	113	q	
72	114	r	
73	115	s	

74	116	t	
75	117	u	
76	118	v	
77	119	w	

78	120	x	
79	121	y	
7A	122	z	
7B	123	{	

7C	124		
7D	125	}	
7E	126	~	
7F	127	Delete	

# Appendix 3. Function keys



Insert



Delete



Home



End



Up Arrow



Down Arrow



Left Arrow



Right Arrow



Shift



ESC



Ctrl



Alt



Page Up



Page Down



F1



F2



F3



F4

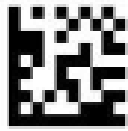

F5

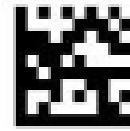

F6

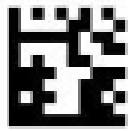

F7

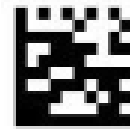

F8



F9

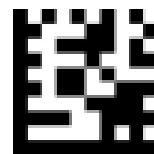

F10

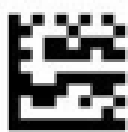

F11



F12